

DOS16-05T DOH16-05T

DC-DC CONVERTER

UP TO 16 Amps



FEATURES

- NO MINIMUM LOAD REQUIRED
- SMALL SIZE AND LOW PROFILE :
SMD TYPE:1.30 X 0.53 X 0.30 INCH , SIP TYPE:2.00 X 0.50 X 0.28 INCH
- SMD PACKAGE QUALIFIED FOR LEADFREE REFLOW SOLDER PROCESS ACCORDING IPC J-STD-020D
- UL60950-1, EN60950-1, & IEC60950-1 SAFETY APPROVALS
- CE MARKED
- COMPLIANT TO RoHS II & REACH

APPLICATIONS

- WIRELESS NETWORK
- TELECOM/DATACOM
- INDUSTRY CONTROL SYSTEM
- DISTRIBUTED POWER ARCHITECTURES
- SEMICONDUCTOR EQUIPMENT
- MICROPROCESSOR POWER APPLICATIONS

REMOTE
CONTROL

UVP

OCP

SCP

TECHNICAL SPECIFICATION

All specifications are typical at nominal input, full load and 25°C otherwise noted

Model Number	Input Range VDC	Output Voltage VDC	Output Current @ Full Load A	Input Current Vin(nom) @ No Load	Efficiency Vin(nom),3.3VDC C@Full Load %	Maximum Capacitor Load (1)
				0.75VDC / 3.3VDC mA		ESR ≥ 1mΩ / ESR ≥ 10mΩ μF
DOS16-05T DOS16-05T-P DOH16-05T DOH16-05T-P DOH16-05TA DOH16-05TA-P	2.4 ~ 5.5 Vin(min.)=Vout(set)+0.5	0.75 ~ 3.3	16	100 / 130	95	1000 / 5000

PART NUMBER STRUCTURE

DOS16 - **05** **T** - **P**

Series Name	Input Voltage (VDC)	Package	Remote Control Option
DOS16: SMD TYPE DOH16: SIP TYPE	05: 2.4~5.5	SMD TYPE SIP TYPE T:No Assembly T:Vertical Mounting SIP TA:Horizontal Mounting SIP	□: Negative Logic P: Positive Logic

INPUT SPECIFICATIONS

Parameter	Conditions	Min.	Typ.	Max.	Unit
Operating input voltage range	Vout(set) < Vin-0.5VDC	2.4	5	5.5	VDC
Maximum input current	Vin=2.4 to 5.5VDC, Io=Io(max.)		16		A
Input reflected ripple current	5~20MHz, 1μH source impedance		100		mAp-p
Start-up voltage			2.2		VDC
Shutdown voltage			2.0		VDC
Input filter (2)					Capacitor type

OUTPUT SPECIFICATIONS

Parameter	Conditions	Min.	Typ.	Max.	Unit
Voltage accuracy	% of Vout(set)	-2.0		+2.0	%
Line regulation	Vin=Vout(set)+0.5VDC to Vin(max.) at Full Load	-0.3		+0.3	%
Load regulation	No Load to Full Load	-0.4		+0.4	%
Voltage adjustability (3)		0.7525		3.63	VDC
Ripple and noise	Measured by 20MHz bandwidth, with a 1μF MLCC & a 10μF T/C			15	mVrms
				50	mVp-p
Temperature coefficient		-0.4		+0.4	%/°C
Dynamic load response	With a 1μF MLCC & a 10μF T/C ΔIo/Δt=2.5A/μs, Vin(nom) Peak deviation		300		mV
	50% load step change Setting time(Vout<10%peak deviation)		25		μs
Dynamic load response	With 2pcs of 150μF polymer capacitors ΔIo/Δt=2.5A/μs, Vin(nom) Peak deviation		150		mV
	50% load step change Setting time(Vout<10%peak deviation)		100		μs
Over load protection	% of Iout rated		180		%
Short circuit protection			Continuous, automatic recovery		
Output voltage overshoot-startup	Vin=2.4~5.5VDC at Full Load		1.0		%

GENERAL SPECIFICATIONS

Parameter	Conditions	Min.	Typ.	Max.	Unit
Isolation voltage					None
Switching frequency		270	300	330	kHz
Safety approvals					UL60950-1 EN60950-1 IEC60950-1
Weight					6.0g (0.21oz)
MTBF	MIL-HDBK-217F, Full load				3.238 x 10 ⁶ hrs

ENVIRONMENTAL SPECIFICATIONS

Parameter	Conditions	Min.	Typ.	Max.	Unit
Operating ambient temperature	With derating	-40		+85	°C
Over temperature protection			125		°C
Storage temperature range		-55		+125	°C
Thermal shock					MIL-STD-810F
Vibration					MIL-STD-810F
Relative humidity(non-condensing)					5% to 95% RH
Lead-free reflow solder process					IPC J-STD-020D
Moisture sensitivity level(MSL)					IPC J-STD-033B Level 2a

FEATURE SPECIFICATIONS

Parameter	Conditions	Min.	Typ.	Max.	Unit
Remote ON/OFF (4)	Referred to -Vin pin Negative logic DC-DC ON (Standard) DC-DC OFF Positive logic DC-DC ON (Option) DC-DC OFF Input current of Ctrl pin Remote off input current	0.01		1.0	mA
Remote sense range			1.5		mA
Rise time	Time for Vout to rise from 10% to 90% of Vout(set)			0.5	VDC
Turn-on delay time	Case 1 (5), Case 2 (6)		1		ms

Note:

1. Test by minimum input and constant resistive load.
2. It's necessary to equip the external input capacitors at the input of the module. The capacitors should connect as close as possible to the input terminals that ensuring module stability. The external C_{in} is 4pcs of 150 μ F low-ESR polymer capacitors // 4pcs of 47 μ F ceramic capacitors at least.
3. Output voltage programmable from 0.75V to 3.3V by connecting a single resistor (shown as Trim Table) between the Trim and GND pins of the module. To calculate the value of the resistor R_{trim} for a particular output voltage V_{out} , use the following equation:

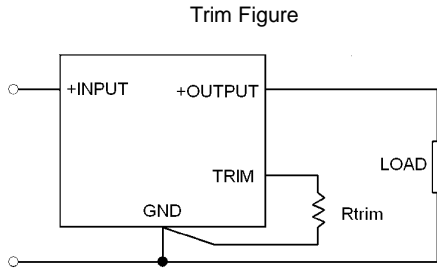

Trim Table

Vout(set) (VDC)	Rtrim (k Ω)
0.7525	Open
1.2	41.973
1.5	23.077
1.8	15.004
2.5	6.974
3.3	3.160

4. Positive logic: ON/OFF is open collector/drain logic input
Negative logic: ON/OFF pin is open collector/drain logic input with external pull-up resistor
5. Case 1: ON/OFF input is set to logic low (module on) and then input power is applied (delay from instant at which $V_{in}=V_{in(min)}$) until $V_{out}=10\%$ of $V_{out(set)}$)
6. Case 2: Input power is applied for at least one second and then the ON/OFF input is set to logic low (delay from instant at which $V_{on/off}=0.3VDC$ until $V_{out}=10\%$ of $V_{out(set)}$)

CAUTION: This power module is not internally fused. An input line fuse must always be used.

CHARACTERISTIC CURVE

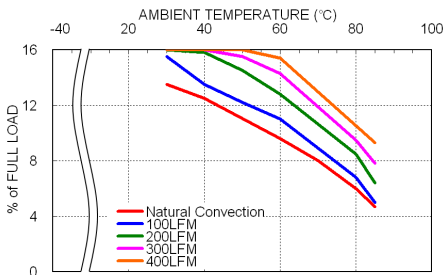

DOS16-05T, Vout=3.3V
Derating Curve

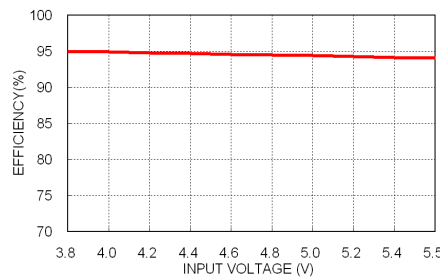

DOS16-05T, Vout=3.3V
Efficiency vs. Input Voltage

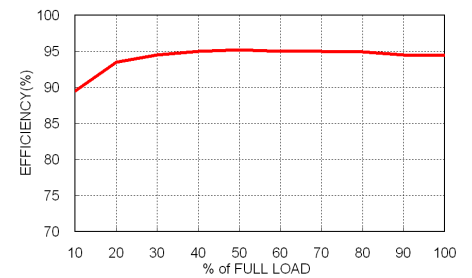

DOS16-05T, Vout=3.3V
Efficiency vs. Output Load

MECHANICAL DRAWING

DOS16-05T

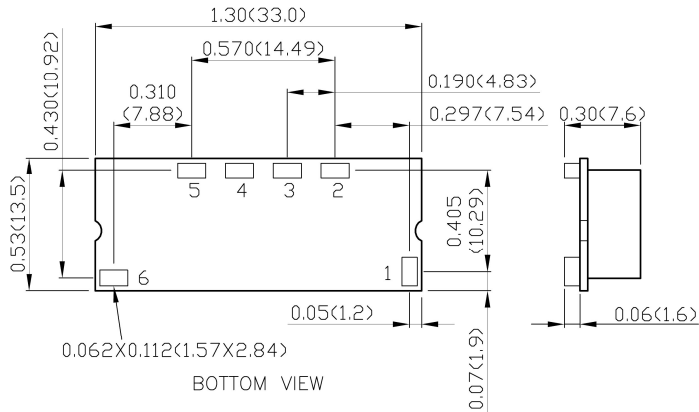

PIN CONNECTION

PIN	DEFINE
1	Ctrl
2	+Sense
3	Trim
4	+Vout
5	GND
6	+Vin

DOH16-05T

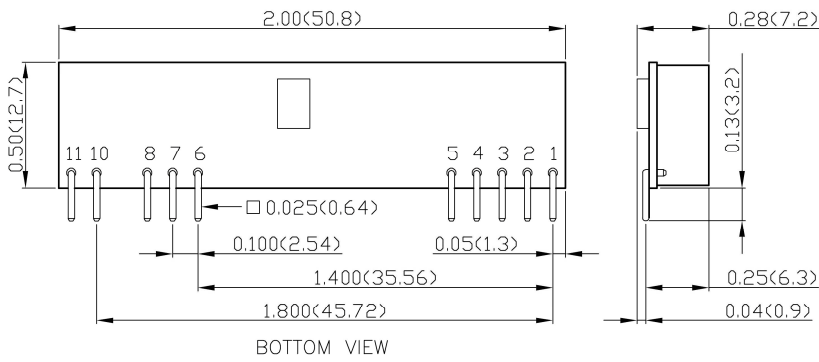

PIN CONNECTION

PIN	DEFINE
1	+Vout
2	+Vout
3	+Sense
4	+Vout
5	GND
6	GND
7	+Vin
8	+Vin
10	Trim
11	Ctrl

DOH16-05TA

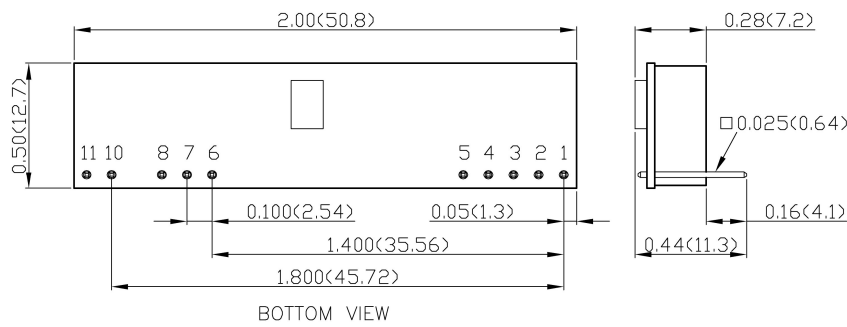

PIN CONNECTION

PIN	DEFINE
1	+Vout
2	+Vout
3	+Sense
4	+Vout
5	GND
6	GND
7	+Vin
8	+Vin
10	Trim
11	Ctrl

1. All dimensions in inch (mm)
2. Tolerance :x.xx±0.02 (x.x±0.5)
x.xxx±0.01 (x.xx±0.25)
3. Pin pitch tolerance ±0.01 (0.25)
4. Pin dimension tolerance ±0.004(0.1)